

107.131

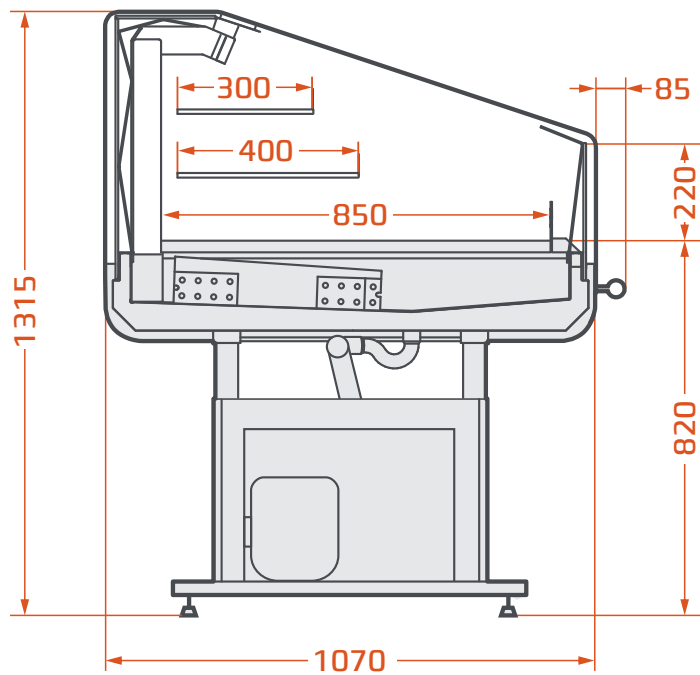

90.90

